

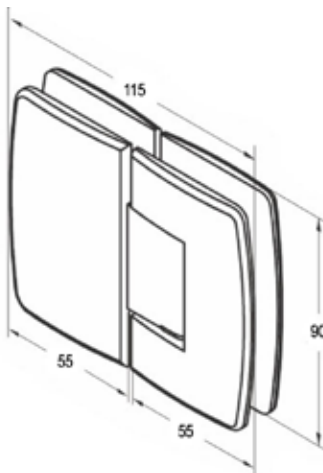

Product Image

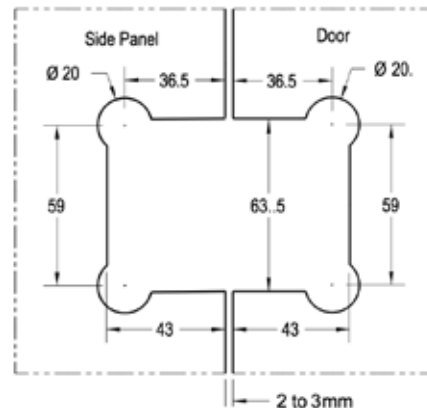

Dimensions



Glass Preparation

DETAILS

Glass to Glass Fix Hinge

- 180° Angle
- Suitable for 8mm & 10mm glass
- 36kg per two hinges with 800mm max door width
- 55kg per three hinges with 915mm max door width
- Supplied with Hex head machine screws

FINISHES

- Polished Chrome

Base Material: Brass