

F002

FRAMELESS GLASS BATHROOM HARDWARE

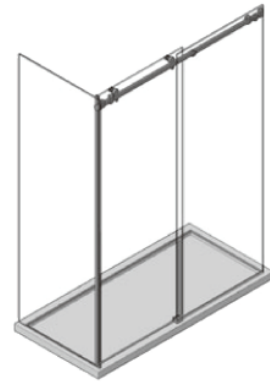

1. Install fixed & side panel using your preferred method (brackets, channel, etc.)
2. Install the mounting block from the ST07 Bracket on the side panel.
3. Install the centre of the mounting block from the ST01 Wall Bracket 12mm inside the fixed panel & in line with the centre of the holes on the fixed panel.
4. Cut the rail to length allowing clearance either end for the mounting blocks inside the ST01 Wall Bracket & ST07 Side Panel Bracket.
5. Slide 2 x ST02 Door Stops onto the rail, one at either end, followed by the ST01 Wall Bracket Sleeve & ST07 Side Panel Bracket Sleeve.
6. Install the rail onto the fixed panel using the 2 x ST05 Button Fixings (remove extra nylon washer for 10mm glass). Slide the ST01 Wall Bracket Sleeve & ST07 Side Panel Bracket Sleeve over the mounting blocks and tighten grub screws.
7. Install the ST04 Rollers to the door and hang door on the rail.
8. Install the ST04 Guides to the door and adjust in conjunction with the Rollers.
9. Slide the ST02 Door Stops into position and tighten grub screws.
10. Install ST03 Floor Guide onto bottom of fixed panel and under door.

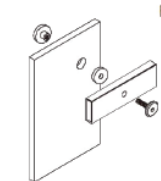
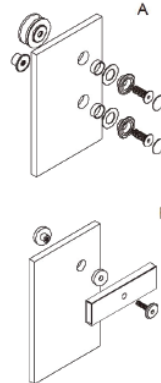
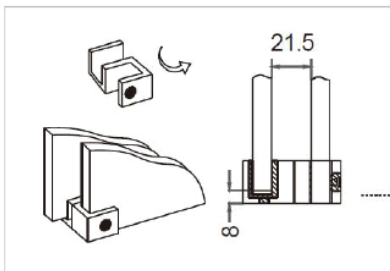
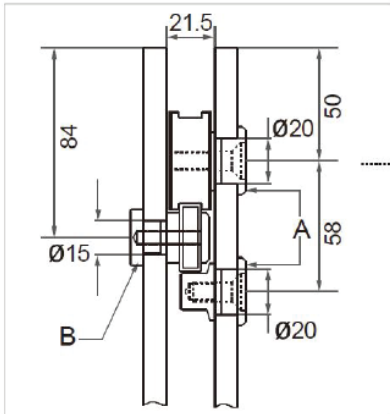
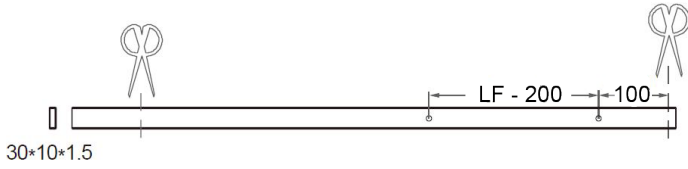

DETAILS

FINISHES

- Modern Sliding Shower System - 2000mm Wall to Glass Fixing Set
- Suitable for 8mm & 10mm glass
 - 45kg weight capacity
 - Includes 1 x F001 & 1 x ST07
 - 3000mm Sliding Rail also available (ST08)

- Polished
- Base Material: 304 Stainless Steel

FRAMELESS GLASS BATHROOM HARDWARE

F002

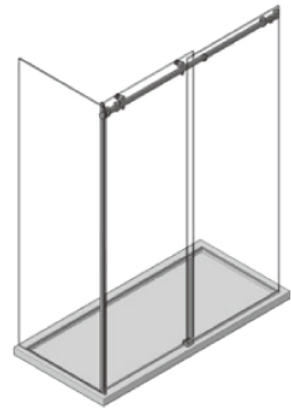
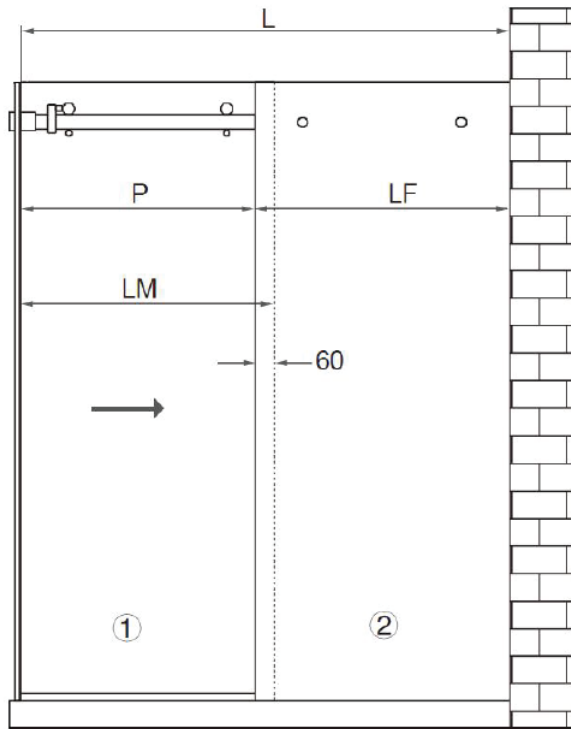

$L = 1150\text{mm to } 2000/3000\text{mm}$
 $P = L/2$
 $LM = P + 60\text{mm}$
 $LF = L - P$

