

FRAMELESS GLASS PIVOT DOOR HARDWARE

FH-105 NHO
FH-105 HO

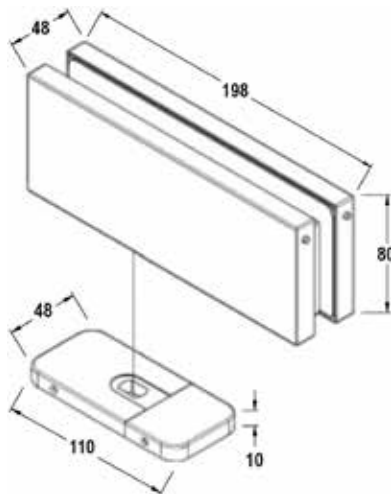

Product Image



Dimensions

Where the radius corner meets the cutout the points should be tipped or R5

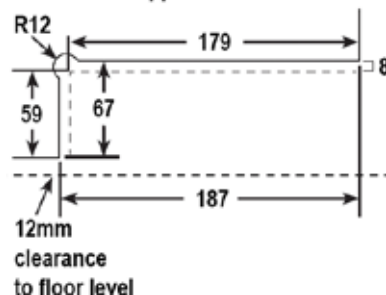

Glass Preparation

DETAILS

High Strength EN5 Ozone Hydraulic Patch Fitting

- Non hold open / Hold Open
- Suitable for 10mm-15mm toughened glass
- Maximum weight of 100kg with a maximum door width of 1250mm (internal) & 1000mm (external)
- 12mm clearance to floor

FINISHES

- Polished
- Satin
- Matt Black

Base material:
Aluminium body
316 Stainless Steel Cover