

Dimensions & Glass Preparation

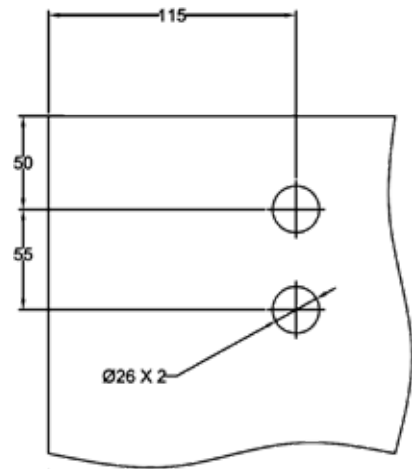

Glass Preparation - Carriage

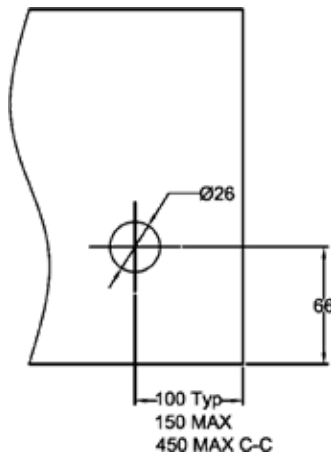

Glass Preparation - Glass Mount

Glass Installation Kit Includes:

- 1 x 2000/3000/4000/6000mm x Ø25mm Tube
- 2 x Carriages
- 2 x End Caps
- 5/6/7/12 x Glass Mounted Bkts
- 2 x Tube Mounted Stops
- 1 x Adjustable Floor Guide
- 1 x Snake Eye Spanner
- No handle included

DETAILS

MTSG-1 Modern Tube Slider Glass Installation Kit

- 100kg weight capacity
- Suitable for 10/12mm toughened glass

FINISHES

- Polished
- Satin
- Matt Black

Base material:
304 Stainless Steel