



Platinum XL Series

15mm and 19mm Toughened Glass

**XL SERIES
PATCH FITTINGS**

Notes:
Max Door Weight 100kg
Max Door Width 1100mm
For 15 - 19mm Toughened Glass

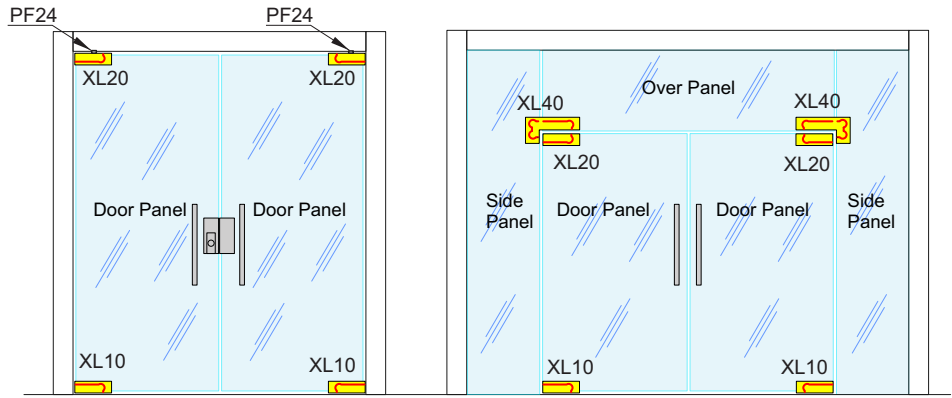

At Floor - Floor springs Dorma BTS80

Bottom Patch Fitting
XL10/SSS

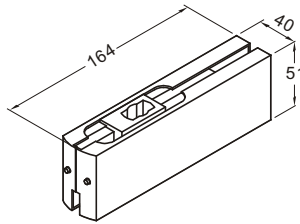

Top Patch Fitting
XL20/SSS

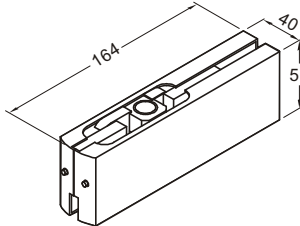

**Full Size Cutouts
on next pages**

Glass Panel Cut Outs

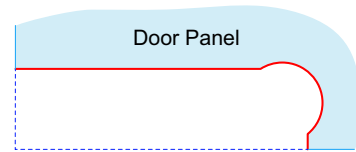

Overpanel to Side Panel Patch Fitting
XL40/SSS

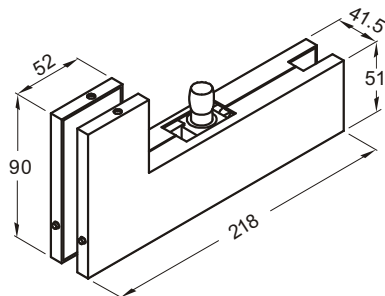

Glass Panel Cut Outs

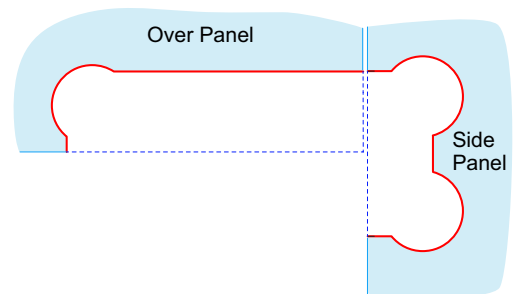

15mm and 19mm Toughened Glass

**XL SERIES
PATCH LOCKS
+ KEEPERS**

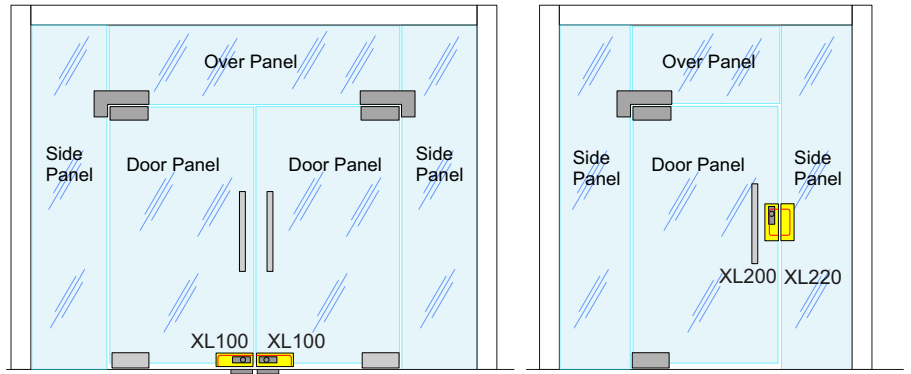

At Floor - Tough Lock Keeper G/PK240/SSS

Bottom Patch Tough Lock
Part No XL100/SSS

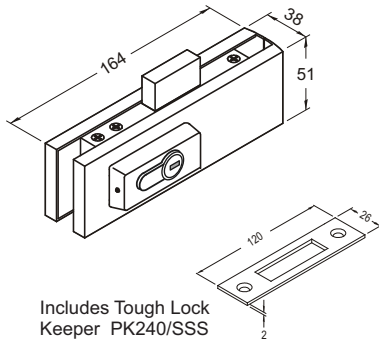

Includes Tough Lock
Keeper PK240/SSS

**Full Size Cutouts
on next pages**

Glass Panel Cut Outs

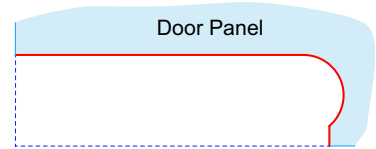

Centre Patch Lock
Part No XL200/SSS

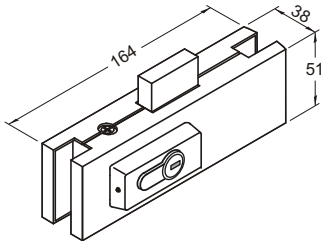

Glass Panel Cut Outs

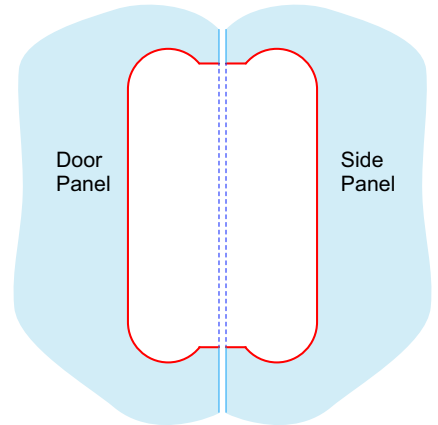

Centre Patch Lock Keeper
Part No XL220/SSS

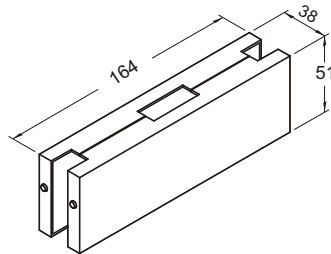

FULL SIZE GLASS CUTOUTS

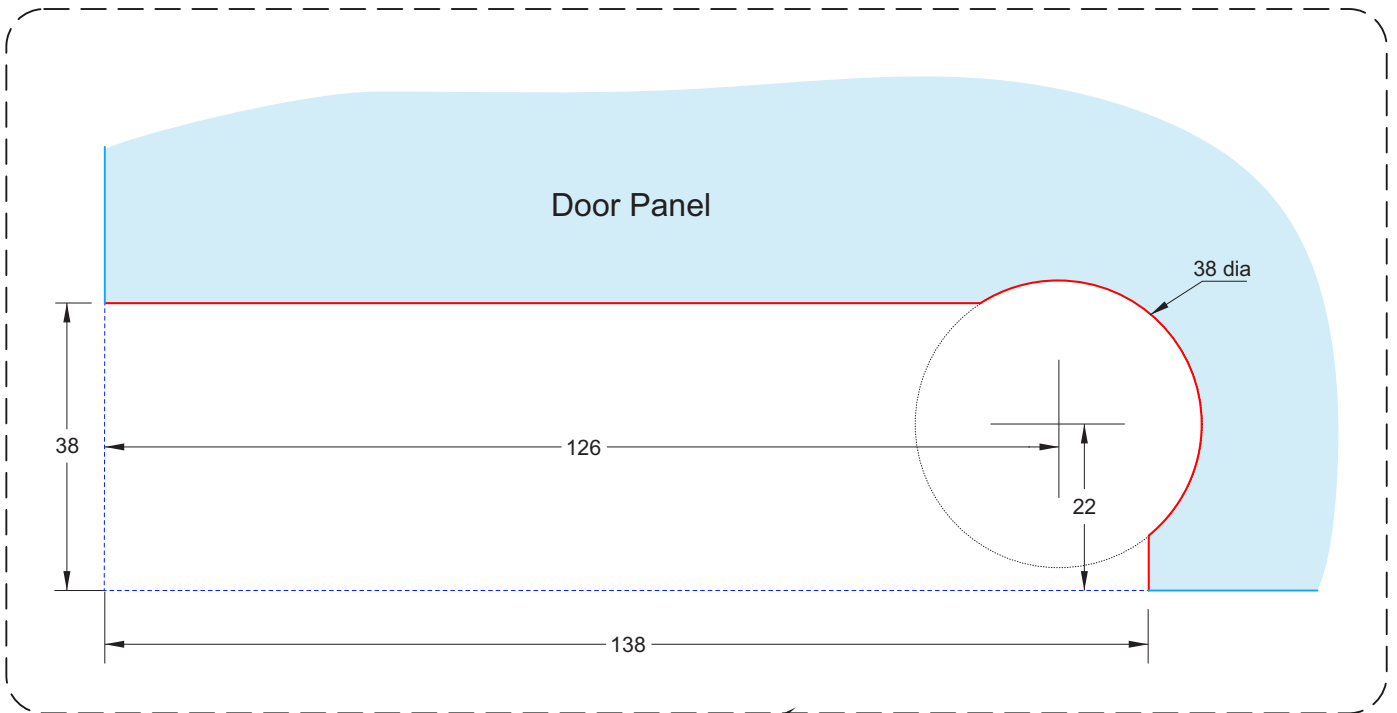

Applies to
**Bottom Patch Fitting
Part No XL10**

**and Top Patch Fitting
Part No XL20**

This Configuration shown

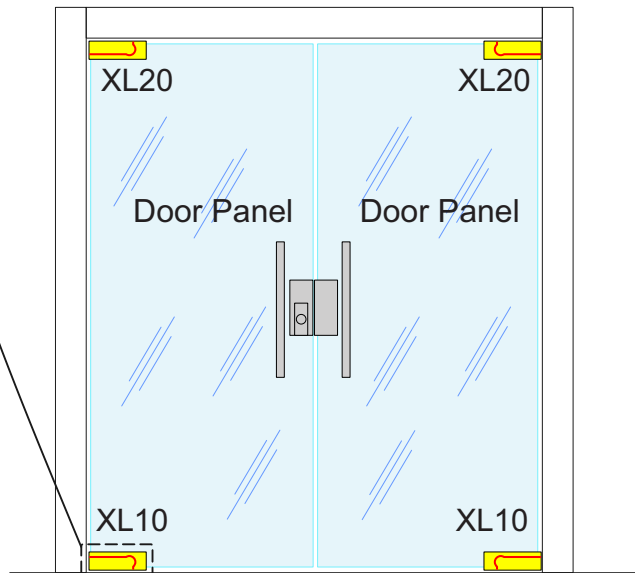

FULL SIZE GLASS CUTOUTS

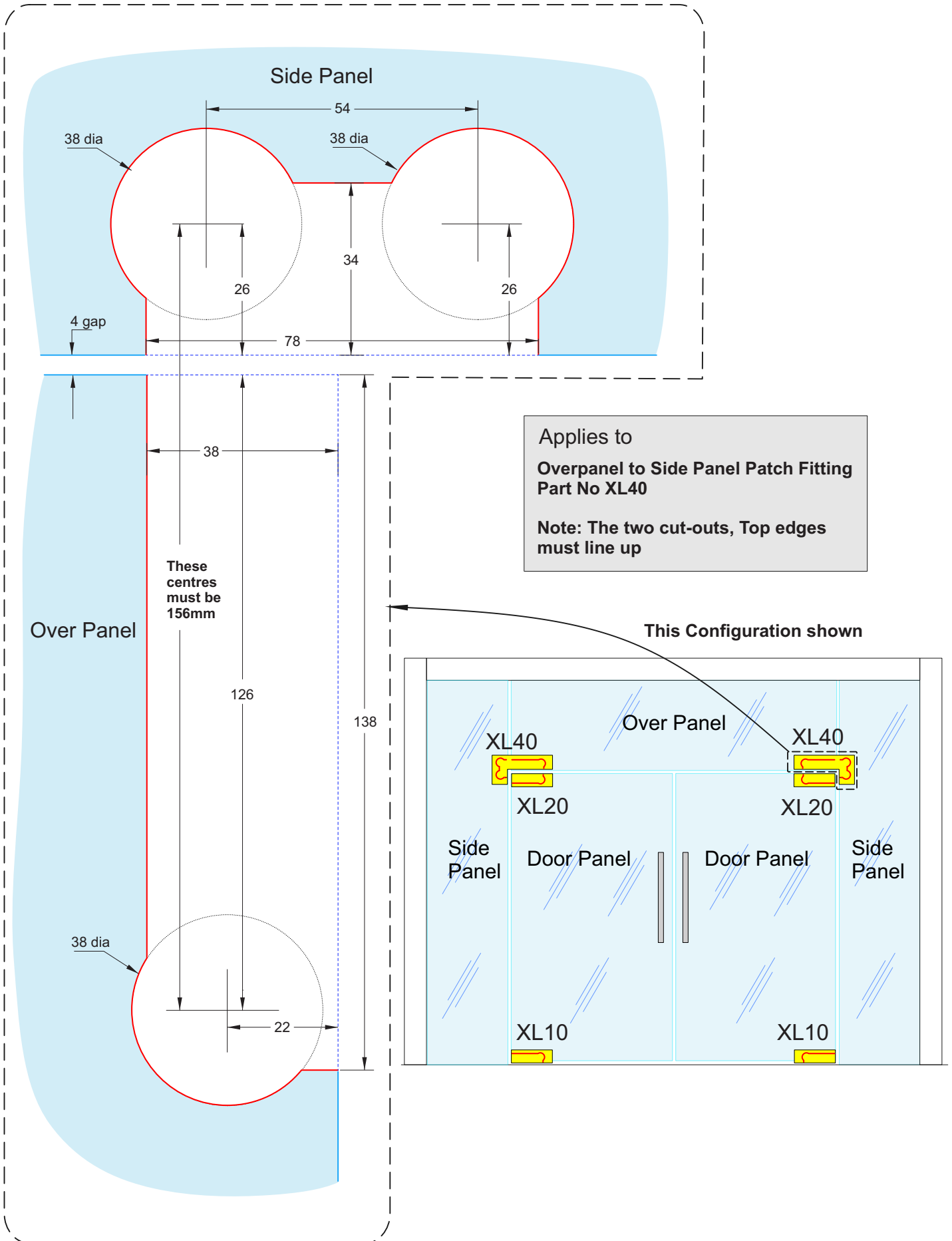

FULL SIZE GLASS CUTOUTS

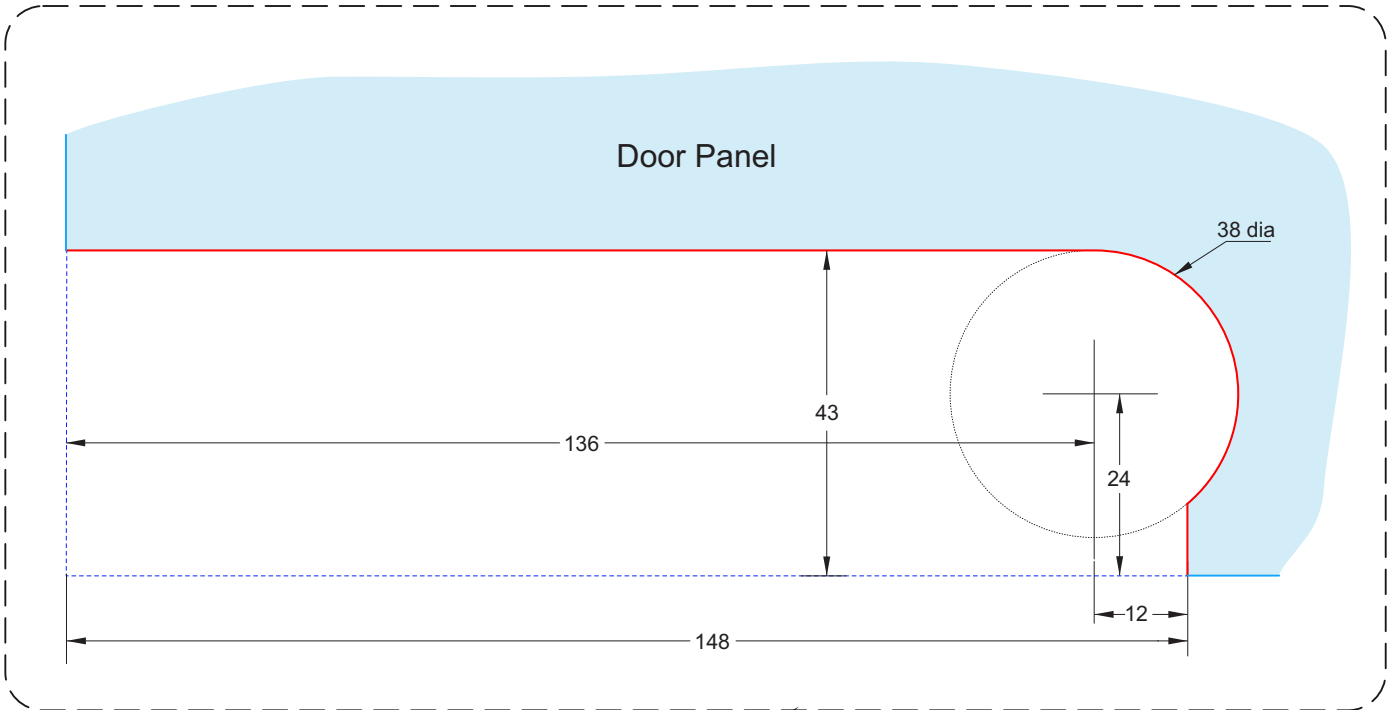

Applies to
**Bottom Lock
Part No XL100**

This Configuration shown

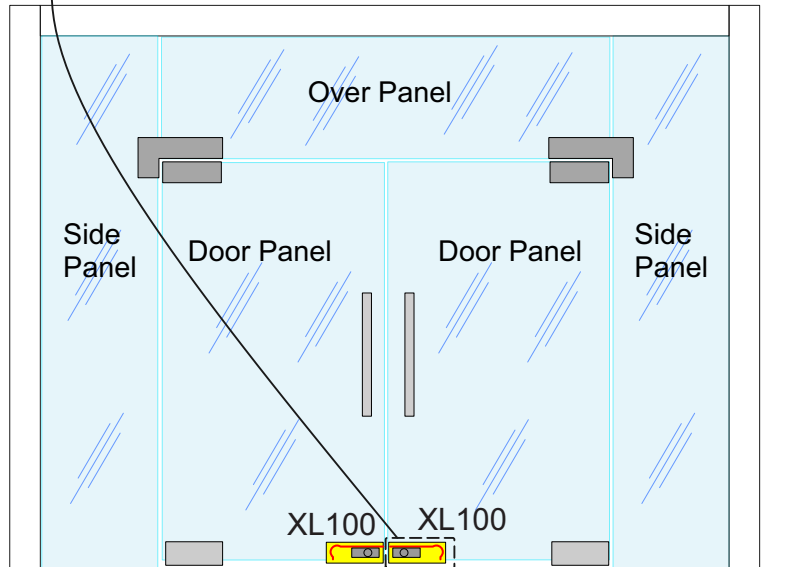

FULL SIZE GLASS CUTOUTS

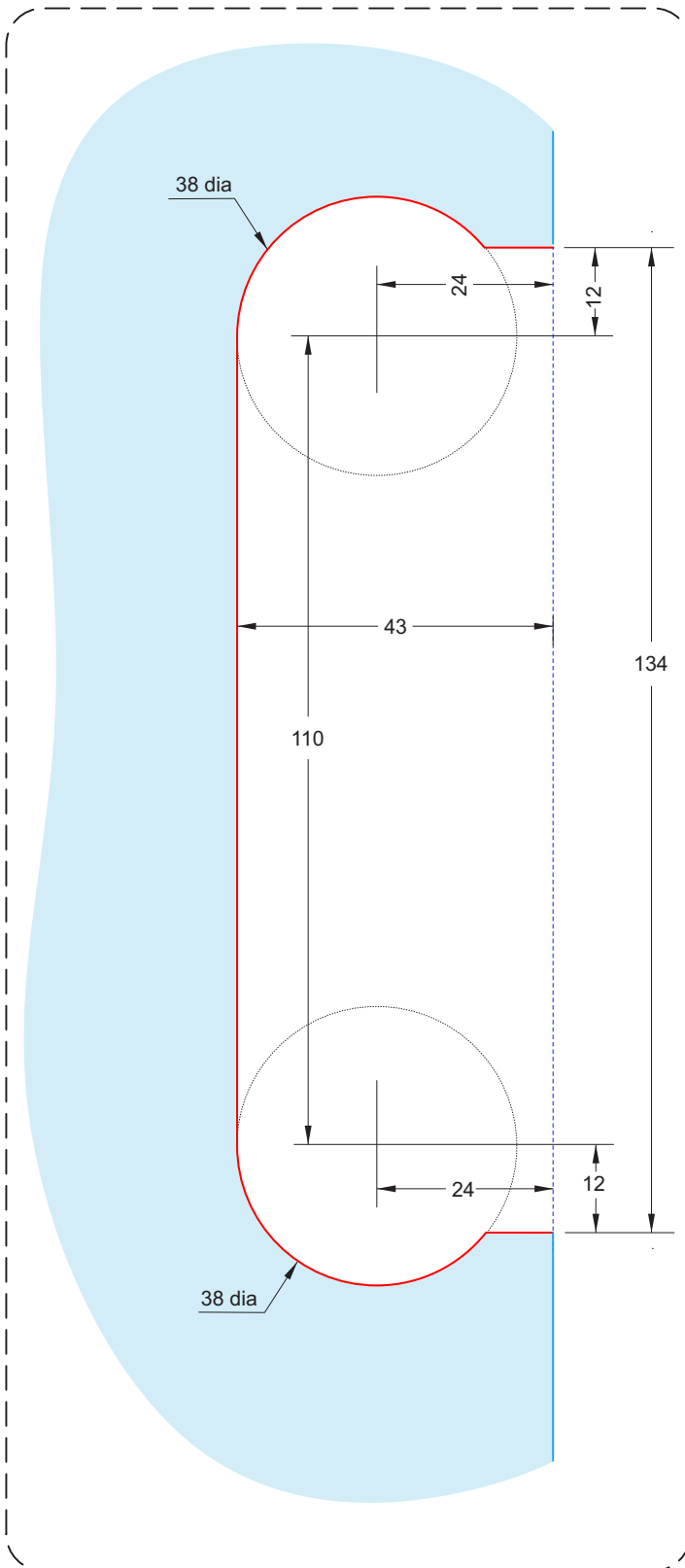

Applies to
Centre Lock
Part No XL200
Centre Lock Keeper
Part No XL220

This Configuration shown

